



FMC920

Small and smart tracker

Quick Manual v3.0

CONTENT

Know your device.....	3
Pinout	4
Wiring scheme.....	5
Set up your device	6
PC Connection (Windows).....	7
How to install USB drivers (Windows)	7
Configuration.....	8
Quick SMS configuration.....	10
Mounting recommendations.....	12
Basic characteristics	13
LED indications.....	13
Electrical characteristics.....	16
Safety information	17
Certification and Approvals	18
Warranty	20
Warranty disclaimer.....	20

KNOW YOUR DEVICE

TOP VIEW (WITHOUT COVER)

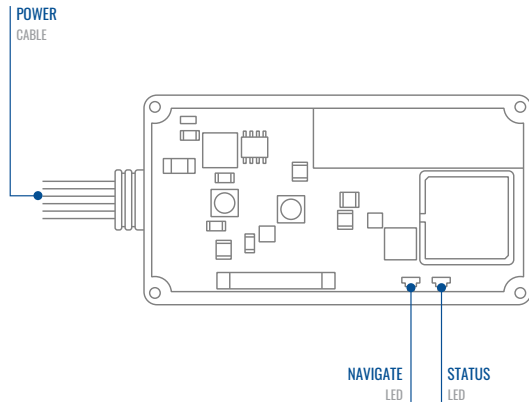

BOTTOM VIEW (WITHOUT COVER)

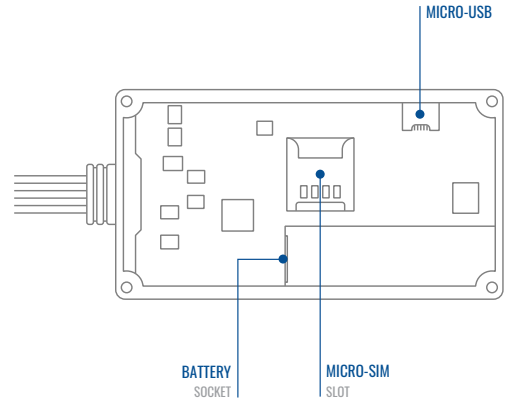

PINOUT

PIN NUMBER	PIN NAME	DESCRIPTION
1	VCC (10-30) V DC (+)	(Red) Power supply (+10-30 V DC)
2	GND (-)	(Black) Ground
3	DIN1	(Yellow) Digital input, channel 1. DEDICATED FOR IGNITION INPUT
4	AIN1	(Grey) Analog input, channel 1. Input range: 0-30 V DC
5	DOUT1	(White) Digital output. Open collector output. Max. 0,5 A DC

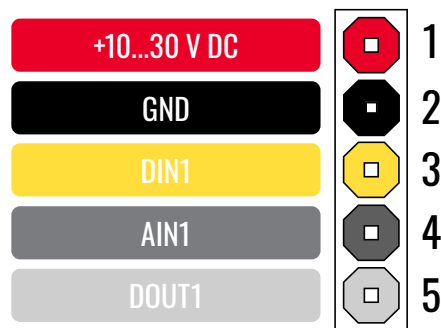

FMC920 pinout

WIRING SCHEME

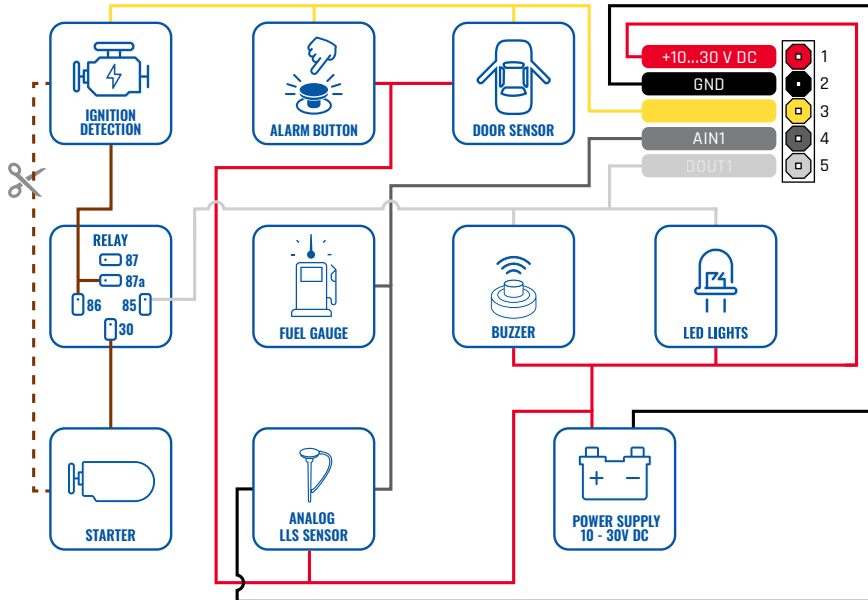

SET UP YOUR DEVICE

HOW TO INSERT MICRO-SIM CARD

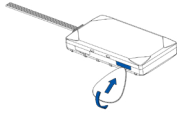

1 COVER REMOVAL

Gently remove FMC920 cover using plastic pry tool from both sides.

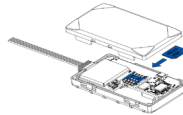

2 MICRO-SIM CARD INSERT

Insert Micro-SIM card as shown with PIN request disabled or read [Security info](#)¹ how to enter it later in Configurator. Make sure that Micro-SIM card cut-off corner is pointing forward to slot.

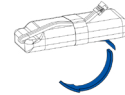

3 REMOVING PROTECTION

Remove the adhesive tape protection.

¹ wiki.teltonika-gps.com/view/FMC920_Security_info

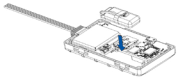

4 PLACING BATTERY

Place the battery inside the casing of the FMC920. Make sure the adhesive tape sticks to the casing.

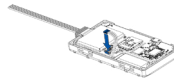

5 CONNECTING BATTERY

Connect the internal battery to the FMC920 PCB.

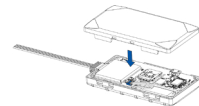

6 ATTACHING COVER BACK

Attach device cover back. Device is ready to be connected.

PC CONNECTION (WINDOWS)

1. Power-up FMC920 with DC voltage (10 – 30 V) power supply using power wires. LED's should start blinking, see "[LED indications](#)".
2. Connect device to computer using **Micro-USB** cable or **Bluetooth®** connection:
 - Using **Micro-USB** cable
 - You will need to install USB drivers, see "[How to install USB drivers \(Windows\)](#)"
 - Using **Bluetooth® wireless technology**
 - FMC920 Bluetooth® technology is enabled by default. Turn on **Bluetooth® connection** on your PC, then select **Add Bluetooth or other device > Bluetooth**. Choose your device named – "FMC920_last_7_imei_digits", without LE in the end.
 - Enter default password **5555**, press **Connect** and then select **Done**.
3. You are now ready to use the device on your computer.

¹Page 13, "LED indications"

²Page 7, "How to install USB drivers (Windows)"

HOW TO INSTALL USB DRIVERS (WINDOWS)

1. Please download COM port drivers from [here](#)¹.
2. Extract and run **TeltonikaCOMDriver.exe**.
3. Click **Next** in driver installation window.
4. In the following window click **Install** button.
5. Setup will continue installing the driver and eventually the confirmation window will appear. Click **Finish** to complete the setup.

¹wiki.teltonika-gps.com/images/d/d0/TeltonikaCOMDriver.zip

CONFIGURATION

At first FMC920 device will have default factory settings set. These settings should be changed according to the users needs. Main configuration can be performed via [Teltonika Configurator](#)¹ software. Get the latest **Configurator** version from [here](#)². Configurator operates on **Microsoft Windows OS** and uses prerequisite **MS .NET Framework**. Make sure you have the correct version installed.

¹ wiki.teltonika-gps.com/view/Teltonika_Configurator

² wiki.teltonika-gps.com/view/Teltonika_Configurator_versions

MS .NET REQUIREMENTS

Operating system	MS .NET Framework version	Version	Links
Windows Vista			
Windows 7			
Windows 8.1	MS .NET 5.0	32 and 64 bit	www.microsoft.com ¹
Windows 10			

¹ dotnet.microsoft.com/en-us/download/dotnet/5.0/runtime

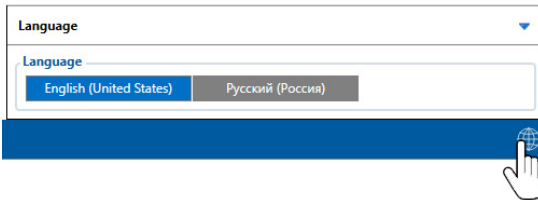

Downloaded Configurator will be in compressed archive. Extract it and launch Configurator.exe. After launch software language can be changed by clicking  in the right bottom corner.





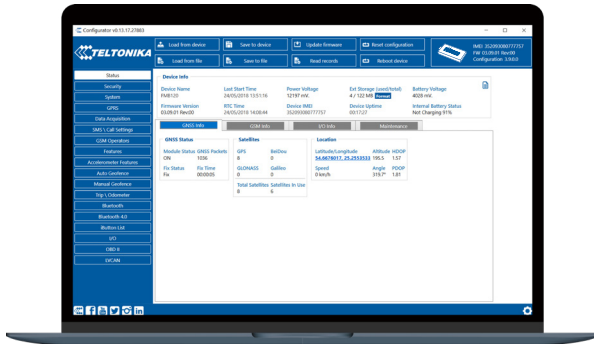





Configuration process begins by pressing on connected device.



After connection to Configurator **Status window** will be displayed.

Various **Status window**¹ tabs display information about **GNSS**², **GSM**³, **I/O**⁴, **Maintenance**⁵ and etc. FMC920 has one user editable profile, which can be loaded and saved to the device. After any modification of configuration the changes need to be saved to device using **Save to device** button. Main buttons offer following functionality:

-  **Load from device** – loads configuration from device.
-  **Save to device** – saves configuration to device.
-  **Load from file** – loads configuration from file.
-  **Save to file** – saves configuration to file.
-  **Update firmware** – updates firmware on device.
-  **Read records** – reads records from the device.
-  **Reboot device** – restarts device.
-  **Reset configuration** – sets device configuration to default.

Most important configurator section is **GPRS** – where all your server and **GPRS settings**⁶ can be configured and **Data Acquisition**⁷ – where data acquiring parameters can be configured. More details about FMC920 configuration using Configurator can be found in our **Wiki**⁸.

¹ wiki.teltonika-gps.com/view/FMC920_Status_info

² wiki.teltonika-gps.com/view/FMC920_Status_info#GNSS_Info

³ wiki.teltonika-gps.com/view/FMC920_Status_info#GSM_Info

⁴ wiki.teltonika-gps.com/view/FMC920_Status_info#I2FO_Info

⁵ wiki.teltonika-gps.com/view/FMC920_Status_info#Maintenance

⁶ wiki.teltonika-gps.com/view/FMC920_GPRS_settings

⁷ wiki.teltonika-gps.com/view/FMC920_Data_acquisition_settings

⁸ wiki.teltonika-gps.com/view/FMC920_Configuration

QUICK SMS CONFIGURATION

Default configuration has optimal parameters present to ensure best performance of track quality and data usage.

Quickly set up your device by sending this SMS command to it:

```
« setparam 2001:APN;2002:APN_username;2003:APN_password;2004:Domain;2005:Port;2006:0»
```

1

2

3

4

5

6

Note: Before SMS text, two space symbols should be inserted.

GPRS SETTINGS:

- 1 2001 – APN
- 2 2002 – APN username (if there are no APN username, empty field should be left)
- 3 2003 – APN password (if there are no APN password, empty field should be left)

SERVER SETTINGS:

- 4 2004 – Domain
- 5 2005 – Port
- 6 2006 – Data sending protocol (0 – TCP, 1 – UDP)

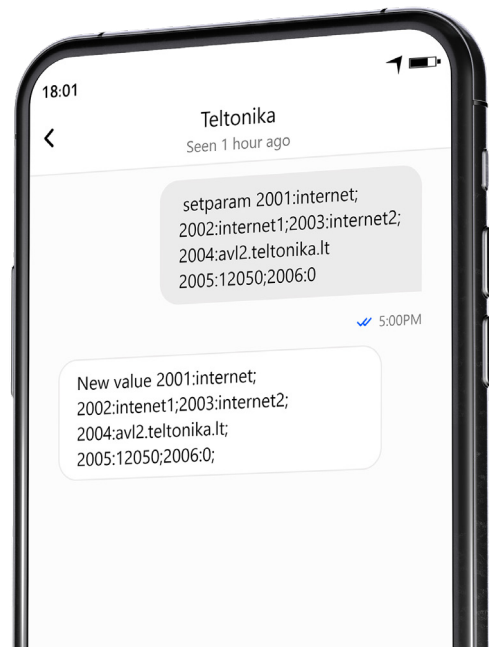

DEFAULT CONFIGURATION SETTINGS

MOVEMENT AND IGNITION DETECTION:



VEHICLE MOVEMENT
will be detected by accelerometer



IGNITION WILL BE DETECTED
by vehicle power voltage
between 13,2 – 30 V

DEVICE MAKES A RECORD ON MOVING IF ONE OF THESE EVENTS HAPPEN:



300 s
300
seconds passes



VEHICLE DRIVES
100 meters



VEHICLE TURNS
10 degrees



SPEED DIFFERENCE
between last coordinate and current
position is greater than 10 km/h

DEVICE MAKES A RECORD ON STOP IF:



1 h
1 HOUR PASSES
while vehicle is stationary and ignition
is off



RECORDS SENDING TO SERVER:

IF DEVICE HAS MADE A RECORD
it is sent to the server every 120 seconds

After successful SMS configuration, FMC920 device will synchronize time and update records to configured server. Time intervals and default I/O elements can be changed by using [Teltonika Configurator¹](#) or [SMS parameters²](#).

¹ wiki.teltonika-gps.com/view/Teltonika_Configurator

² wiki.teltonika-gps.com/view/Template:FMB_Device_Family_Parameter_list

MOUNTING RECOMMENDATIONS

CONNECTING WIRES

- Wires should be fastened to the other wires or non-moving parts. Try to avoid heat emitting and moving objects near the wires.
- The connections should not be seen very clearly. If factory isolation was removed while connecting wires, it should be applied again.
- If the wires are placed in the exterior or in places where they can be damaged or exposed to heat, humidity, dirt, etc., additional isolation should be applied.
- Wires cannot be connected to the board computers or control units.

CONNECTING POWER SOURCE

- Be sure that after the car computer falls asleep, power is still available on chosen wire. Depending on car, this may happen in 5 to 30 minutes period.
- When module is connected, measure voltage again to make sure it did not decrease.
- It is recommended to connect to the main power cable in the fuse box.
- Use 3A, 125V external fuse.

CONNECTING IGNITION WIRE

- Be sure to check if it is a real ignition wire i. e. power does not disappear after starting the engine.
- Check if this is not an ACC wire (when key is in the first position, most of the vehicle electronics are available).
- Check if power is still available when you turn off any of vehicles devices.
- Ignition is connected to the ignition relay output. As alternative, any other relay, which has power output when ignition is on, may be chosen.

CONNECTING GROUND WIRE

- Ground wire is connected to the vehicle frame or metal parts that are fixed to the frame.
- If the wire is fixed with the bolt, the loop must be connected to the end of the wire.
- For better contact scrub paint from the spot where loop is going to be connected.

LED INDICATIONS

NAVIGATION LED INDICATIONS

BEHAVIOUR	MEANING
Permanently switched on	GNSS signal is not received
Blinking every second	Normal mode, GNSS is working
Off	GNSS is turned off because: Device is not working or Device is in sleep mode
Blinking fast constantly	Device firmware is being flashed

STATUS LED INDICATIONS

BEHAVIOUR	MEANING
Blinking every second	Normal mode
Blinking every two seconds	Sleep mode
Blinking fast for a short time	Modem activity
Off	Device is not working or Device is in boot mode

BASIC CHARACTERISTICS

MODULE

Name	FMC920-QJIB0: Quectel EG915U-EU with Teltonika TM2500 FMC920-QKIB0: Quectel EG915U-LA with Teltonika TM2500
Technology	LTE Cat 1/GSM/GPRS/GNSS/ BLUETOOTH® LE

GNSS

GNSS	GPS, GLONASS, GALILEO, BEIDOU, QZSS, AGPS
Receiver	33 channel
Tracking sensitivity	-165 dBm
Accuracy	< 3 m
Hot start	< 1 s
Warm start	< 25 s
Cold start	< 35 s

CELLULAR

Technology	LTE Cat 1, GSM
2G bands	FMC920-QJIB0: GSM: B2/B3/B5/B8 FMC920-QKIB0: GSM: B2/B3/B5/B8

4G bands	FMC920-QJIB0: LTE FDD: B1/B3/B5/ B7/B8/B20/B28 FMC920-QKIB0: LTE FDD: B2/B3/B4/ B5/B7/B8/B28/ B66
Data transfer	LTE: LTE FDD : Max 10Mbps (DL)/ Max 5Mbps (UL) GSM: GPRS: Max 85.6Kbps (DL)/ Max 85.6Kbps (UL)
Transmit power	Class 5 for GSM900: 30±5dBm Class 3 for DCS1800: 29±5dBm Class 3 for LTE-FDD: 26±5dBm Bluetooth: 5.54dBm +/-2dBm Bluetooth LE: -4.26dBm +/-2dBm
Data support	SMS (text/data)

POWER

Input voltage range	10 - 30 V DC with overvoltage protection
Back-up battery	170 mAh Li-Ion battery (0.63Wh)
Internal fuse	3A, 125V
Power consumption	At 12V < 2 mA (Ultra Deep Sleep ¹) At 12V < 3 mA (Deep Sleep ¹) At 12V < 8 mA (Online Deep Sleep ¹) At 12V < 12 mA (GNSS Sleep ¹) At 12V < 28 mA (Nominal with no load) At 12V < 0.25A Max. (with full Load/ Peak)

¹wiki.teltonika-gps.com/view/FMC920_Sleep_modes

BLUETOOTH® TECHNOLOGY

Specification	4.0 + LE
Supported peripherals	EYE beacon and sensor ² , OBDBII dongle ³ , Inateck Barcode Scanner, Universal Bluetooth® LE sensors support

INTERFACE

Digital Inputs	1
Digital Outputs	1
Analog Inputs	1
GNSS antenna	Internal High Gain
Cellular antenna	Internal High Gain
USB	2.0 Micro-USB
LED indication	2 status LED lights
SIM	Micro-SIM
Memory	128MB internal flash memory

PHYSICAL SPECIFICATION

Dimensions	79 x 43 x 12 mm (L x W x H)
Weight	54 g

²teltonika-gps.com/products/accessories/sensors-beacons

³wiki.teltonika-gps.com/view/How_to_connect_OBD_II_Bluetooth_Dongle_to_FMB_device

OPERATING ENVIRONMENT

Operating temperature (with battery)	-20 °C to +40 °C
Operating temperature (without battery)	-40 °C to +85 °C
Storage temperature (without battery)	-40 °C to +85 °C
Storage temperature (with battery)	-20 °C to +60 °C
Operating humidity	5% to 95% non-condensing
Ingress Protection Rating	IP54
Battery charge temperature	0 °C to +45 °C
Battery discharge temperature	-20 °C to +60 °C
Battery storage temperature	-20 °C to +45 °C for 1 month -20 °C to +35 °C for 6 months

FEATURES

Sensors	Accelerometer
---------	---------------

Green Driving, Over Speeding detection, GNSS Fuel Counter, DOUT Control Via Call, Excessive Idling detection, Unplug detection, Towing detection, Crash detection, Auto Geofence, Manual Geofence, Trip⁴

Scenarios

Sleep modes

GPS Sleep, Online Deep Sleep, Deep Sleep, Ultra Deep Sleep⁵

Configuration and firmware update

FOTA Web⁶, FOTA⁷, Teltonika Configurator⁸ (USB, Bluetooth® wireless technology)

SMS

Configuration, Events, DOUT Control, Debug

GPRS commands

Configuration, DOUT control, Debug

Time Synchronization

GPS, NITZ, NTP

Fuel monitoring

LLS (Analog), **OBDDI dongle⁹**

Ignition detection

Digital Input 1, Accelerometer, External Power Voltage, Engine RPM (**OBDDI dongle¹⁰**)

⁴wiki.teltonika-gps.com/view/FMC920_Features_settings

⁵wiki.teltonika-gps.com/view/FMC920_Sleep_modes

⁶wiki.teltonika-gps.com/view/FOTA_WEB

⁷wiki.teltonika-gps.com/view/FOTA

⁸wiki.teltonika-gps.com/view/Teltonika_Configurator

⁹wiki.teltonika-gps.com/view/How_to_connect_OBD_II_Bluetooth_Dongle_to_FMB_device

ELECTRICAL CHARACTERISTICS

CHARACTERISTIC DESCRIPTION	VALUE			
	MIN.	TYP.	MAX.	UNIT
SUPPLY VOLTAGE				
Supply Voltage (Recommended Operating Conditions)	+10		+30	V
DIGITAL OUTPUT (OPEN DRAIN GRADE)				
Drain current (Digital Output OFF)			120	μA
Drain current (Digital Output ON, Recommended Operating Conditions)			0.5	A
Static Drain-Source resistance (Digital Output ON)			300	mΩ
DIGITAL INPUT				
Input resistance (DIN1)	47			kΩ
Input voltage (Recommended Operating Conditions)	0		30	V
Input Voltage threshold		2.5		V

CHARACTERISTIC DESCRIPTION	VALUE			
	MIN.	TYP.	MAX.	UNIT
ANALOG INPUT				
Input Voltage (Recommended Operating Conditions)	0		30	V
Input resistance		150		kΩ
Measurement error on 12V		3		%
Additional error on 12V		360		mV
Measurement error on 30V		3		%
Additional error on 30V		900		mV

SAFETY INFORMATION

This message contains information on how to operate FMC920 safely. By following these requirements and recommendations, you will avoid dangerous situations. You must read these instructions carefully and follow them strictly before operating the device!

- The device uses SELV limited power source. The nominal voltage is +12 V DC. The allowed voltage range is +10...+30 V DC.
- To avoid mechanical damage, it is advised to transport the device in an impact-proof package. Before usage, the device should be placed so that its LED indicators are visible. They show the status of device operation.
- When connecting the connection (1x5) cables to the vehicle, the appropriate jumpers of the power supply of the vehicle should be disconnected.
- Before dismantling the device from the vehicle, the 1x5 connection must be disconnected.
- The device is designed to be mounted in a zone of limited access, which is inaccessible to the operator. All related devices must meet the requirements of EN 62368-1 standard.
- The device FMC920 is not designed as a navigational device for boats.



Do not disassemble the device. If the device is damaged, the power supply cables are not isolated or the isolation is damaged, DO NOT touch the device before unplugging the power supply.



All wireless data transferring devices produce interference that may affect other devices which are placed nearby.



The device must be connected only by qualified personnel.



The device must be firmly fastened in a predefined location.



The programming must be performed using a PC with autonomic power supply.



Installation and/or handling during a lightning storm is prohibited.



The device is susceptible to water and humidity.

CERTIFICATION AND APPROVALS



This sign on the package means that it is necessary to read the User's Manual before your start using the device. Full User's Manual version can be found in our [Wiki](#)¹.

¹wiki.teltonika-gps.com/view/FMC920



Hereby, Teltonika declare under our sole responsibility that the above described product is in conformity with the relevant Community harmonization: European Directive 2014/53/EU (RED).



UK Conformity Assessed (UKCA) marking is a conformity mark that indicates conformity with the applicable requirements for above described products sold within Great Britain.



The **RoHS**¹ is a directive regulating the manufacture, import and distribution of Electronics and Electrical Equipment (EEE) within the EU, which bans from use 10 different hazardous materials (to date).

¹wiki.teltonika-gps.com/view/FMC920_RoHS



The standard aims to provide users more detailed information than vague marketing terms such as waterproof.



This sign on the package means that all used electronic and electric equipment should not be mixed with general household waste.



E-Mark and e-Mark are the European conformity marks issued by the transport sector, indicating that the products comply with relevant laws and regulations or directives. Vehicles and related products need to go through the E-Mark certification process to be legally sold in Europe.



REACH addresses the production and use of chemical substances, and their potential impacts on both human health and the environment. Its 849 pages took seven years to pass, and it has been described as the most complex legislation in the Union's history and the most important in 20 years. It is the strictest law to date regulating chemical substances and will affect industries throughout the world.

DECLARATION OF IMEI ASSIGNMENT

The IMEI number is used by a GSM network to identify valid devices and therefore can be used for stopping a stolen phone from accessing that network. For example, if a mobile phone is stolen, the owner can call their network provider and instruct them to blacklist the phone using its IMEI number. This renders the phone useless on that network and sometimes other networks too, whether or not the phone's subscriber identity module (SIM) is changed.



Para maiores informações, consulte o site da ANATEL www.anatel.gov.br
Este equipamento não tem direito à proteção contra interferência prejudicial e não pode causar interferência em sistemas devidamente autorizados.

For more information, see the ANATEL website www.anatel.gov.br
This equipment is not entitled to protection against harmful interference and must not cause interference in duly authorized systems.

DECLARATION OF DEVICE OPERATION TEMPERATURE

An operating temperature is the temperature at which an electrical or mechanical device operates. The device will operate effectively within a specified temperature range which varies based on the device function and application context, and ranges from the minimum operating temperature to the maximum operating temperature (or peak operating temperature). Outside this range of safe operating temperatures the device may fail.



The Bluetooth® word mark and logos are registered trademarks owned by Bluetooth SIG, Inc. and any use of such marks by UAB Teltonika Telematics is under license. Other trademarks and trade names are those of their respective owners.

CHECK ALL CERTIFICATES

All newest certificates may be found in our [Wiki](#)².

² wiki.teltonika-gps.com/view/FMC920_Certification_%26_Approvals

WARRANTY

We guarantee our products 24-month warranty¹ period.

All batteries carry a 6-month warranty period.

Post-warranty repair service for products is not provided.

If a product stops operating within this specific warranty time, the product can be:

- Repaired
- Replaced with a new product
- Replaced with an equivalent repaired product fulfilling the same functionality
- Replaced with a different product fulfilling the same functionality in case of EOL for the original product

¹ Additional agreement for an extended warranty period can be agreed upon separately.

WARRANTY DISCLAIMER

- Customers are only allowed to return products as a result of the product being defective, due to order assembly or manufacturing fault.
- Products are intended to be used by personnel with training and experience.
- Warranty does not cover defects or malfunctions caused by accidents, misuse, abuse, catastrophes, improper maintenance or inadequate installation – not following operating instructions (including failure to heed warnings) or use with equipment with which it is not intended to be used.
- Warranty does not apply to any consequential damages.
- Warranty is not applicable for supplementary product equipment (i. e. PSU, power cables, antennas) unless the accessory is defective on arrival.
- [More information on what is RMA¹](#)

¹ wiki.teltonika-gps.com/view/RMA_guidelines